



# BD35004

**35W HIGH-VOLTAGE DC/DC CONVERTER**  
*Single 430V<sub>OUT</sub> (±215V)*

## Key Features

- 85% efficiency
- Input under/overvoltage protection
- Input-to-output isolation
- Soft start
- Dual short circuit protection
- 500µA off-state current
- Multiple converter synchronization
- Adjustable outputs
- 100kHz switching frequency
- Thermal protection
- Six-sided shielding



## Functional Description

The BD35004 is a 35W High-Voltage DC/DC Converter with a nominal input voltage of 24V<sub>IN</sub> (with a range of 18–36V<sub>IN</sub>) and an output set for 430V<sub>OUT</sub>@81mA.

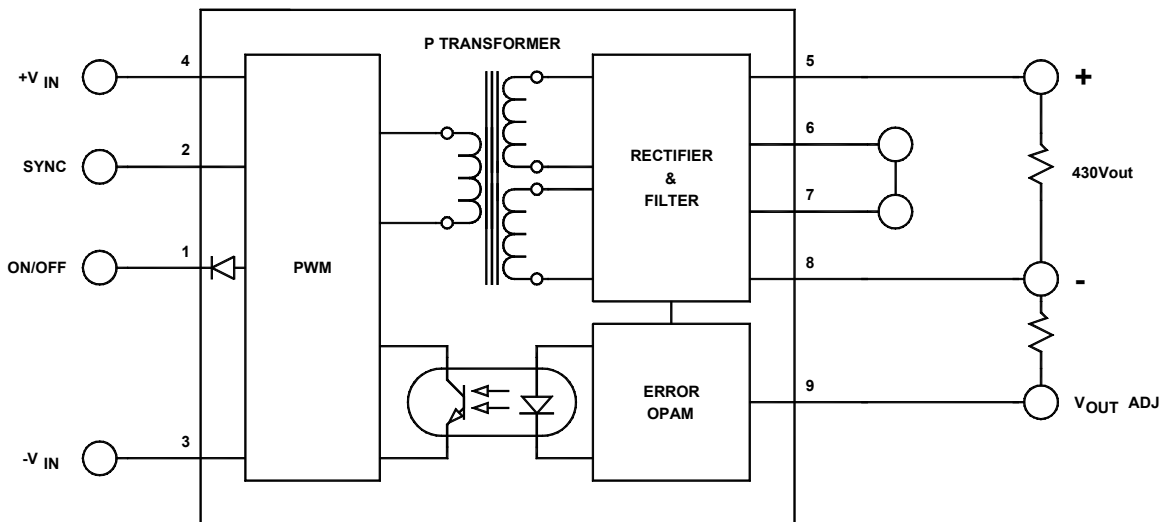

Typical Block Diagram

## Electrical Specifications

### INPUT SPECIFICATIONS

Unless otherwise specified, all parameters are given under typical +25°C with nominal input voltage and under full output load conditions.

PARAMETER	CONDITION / NOTE	MIN	TYP	MAX	UNIT
Input Voltage Range		18	24	36	Vdc
Input Startup Voltage				17	Vdc
Input Overvoltage Protection		37			Vdc
Input Filter	Pi ( $\pi$ )				
Reverse Polarity	External series-blocking diode				
Reflected Ripple <sup>1</sup>	$I_o = FL, C_N = 10\mu F$		100		mA <sub>PP</sub>
No Load Input Current			40		mA
Full Load <sup>2</sup>			1700		mA
Input Surge Current (20 $\mu$ S Spike)				10	A
Short Circuit Current Limit	See Short Circuit Protection		150		% I <sub>N</sub>
Off State Current			500		$\mu$ A
Remote ON/OFF Control					
Supply ON	Pin 1 Open (Open circuit voltage: 13V max.)				
Supply OFF		0		0.8	Vdc
Logic Input Reference	-Input for ON/OFF and SYNC				
Logic Compatibility for Reference	TTL Open Collector or CMOS Open Drain				
Sync, High	See External Synchronization, Figure 3	2		6	Vdc
Sync, Low	See External Synchronization, Figure 3	0		0.8	Vdc

### OUTPUT SPECIFICATIONS

PARAMETER	CONDITION / NOTE	MIN	TYP	MAX	UNIT
Output Voltage	Measured between Pins 5 and 8		430		Vdc
Output Voltage Accuracy	See formulas for RT in Figure 1B		$\pm 1$	$\pm 2$	%
Output Current			81		mA
Ripple & Noise	(See App. Note DC-003)		1	2	%V <sub>PP</sub> of V <sub>OUT</sub>
Line Regulation, Single			$\pm 0.5$	$\pm 1$	%
Load Regulation, Single			$\pm 1$	$\pm 2$	%
Temperature Coefficient @ FL			0.02		%/°C
Transient Response Time	50% FL to FL to 50% FL		250		$\mu$ S
Short Circuit Protection	By input current limiting				
Output Adjust Range	See Figure 1B, (See App. Note DC-010)	$\pm 5$		$\pm 10$	%

### GENERAL SPECIFICATIONS

PARAMETER	CONDITION / NOTE	MIN	TYP	MAX	UNIT
Efficiency			85		%
Isolation Voltage (1 min.), Input to Output			1500		Vdc
Isolation Resistance			10 <sup>9</sup>		$\Omega$
Isolation Capacitance			2700		pF
Switching Frequency			100		kHz
Turn On Delay	See Figure 5		7	10	mS
Soft Start Time	See Figure 5		7	15	mS

### PHYSICAL CHARACTERISTICS

PARAMETER	CONDITION / NOTE	MIN	TYP	MAX	UNIT
Size (L×W×H)	2.00×2.00×0.50 in. (50.80×50.80×12.70mm)				
Weight	2.43 oz. (69g)				
Case Material	Coated metal				
Shielding Connection, 24V <sub>N</sub>	-V <sub>N</sub> (Pin 3)				

## ENVIRONMENTAL SPECIFICATIONS

PARAMETER	CONDITION / NOTE	MIN	TYP	MAX	UNIT
Operating Temperature Range (Ambient)*	See Figure 2	-40		+71	°C
Storage Temperature Range		-55		+125	°C
Thermal Resistance	°C per watt internally dissipated		7		°C/W <sub>DISS</sub>
Maximum Operating Case Temperature				110	°C
Derating	See Figure 2				
Cooling	Free-air convection				
EM/RFI	Six-sided continuous shielded metal case				
MTBF	per MIL-HNBK-217F (Ground benign, +25°C)		1.1×10 <sup>6</sup>		hours
Humidity	Up to 95% non-condensing				
Thermal Shutdown	Case Temperature		110	115	°C
Thermal Hysteresis		2	5		°C

\* See footnotes 3 and 4

<sup>1</sup> Measured with 10µF capacitor at the input power pins.

<sup>2</sup> The maximum input current at any given input range measured at minimum input voltage is given as 1.6\*I<sub>NOMINAL</sub>. Nominal input current is the typical value measured at the input of the converter under full-load room temperature and nominal input voltage (24Vdc).

<sup>3</sup> Adequate insulation is to be provided to the converters at the end usage as per applicable requirements.

<sup>4</sup> Temperature rise on the case of the converters is to be considered during the end usage as per applicable requirements.

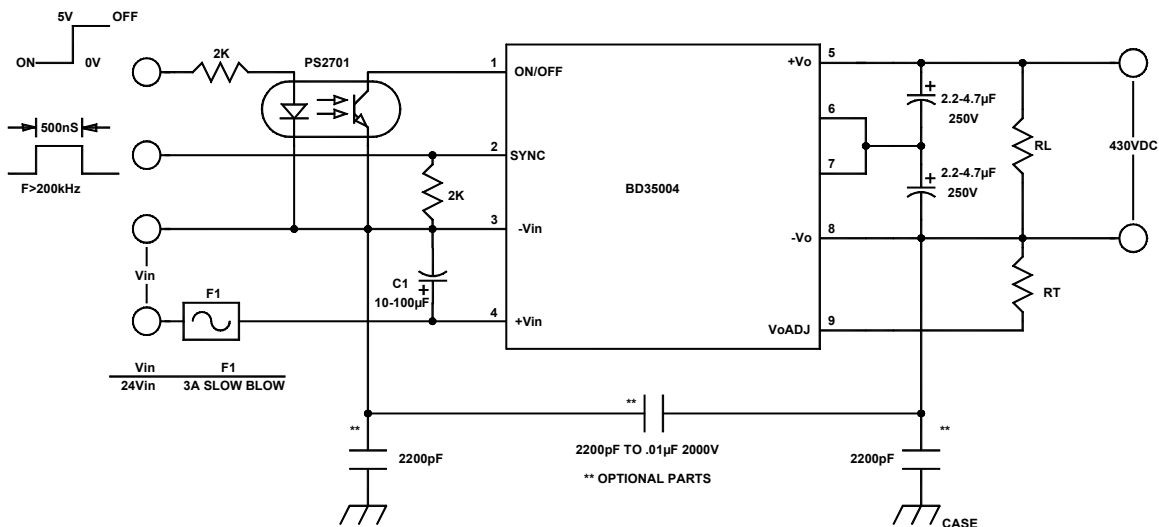

FIGURE 1A. Typical connection diagram

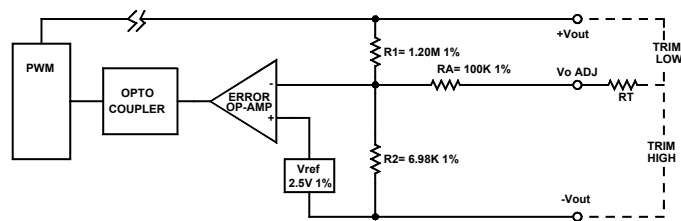

FIGURE 1B. Output control circuit

To trim  $V_o$  higher to  $V_o'$ , where  $V_o$  is the actual measured value:

$$RT = \frac{R_1 \cdot V_{REF}}{V_o' - V_o} \quad \text{For the above given values: } RT = \frac{3 \cdot 10^6}{V_o' - V_o} - 100k$$

To trim  $V_o$  lower to  $V_o''$ , where  $V_o$  is the actual measured value:

$$RT = \left[ \left( \frac{R_1 \cdot 2 \cdot V_{REF}}{R_2 (V_o - V_o'')} - R_1 \right) - 100k \right]$$

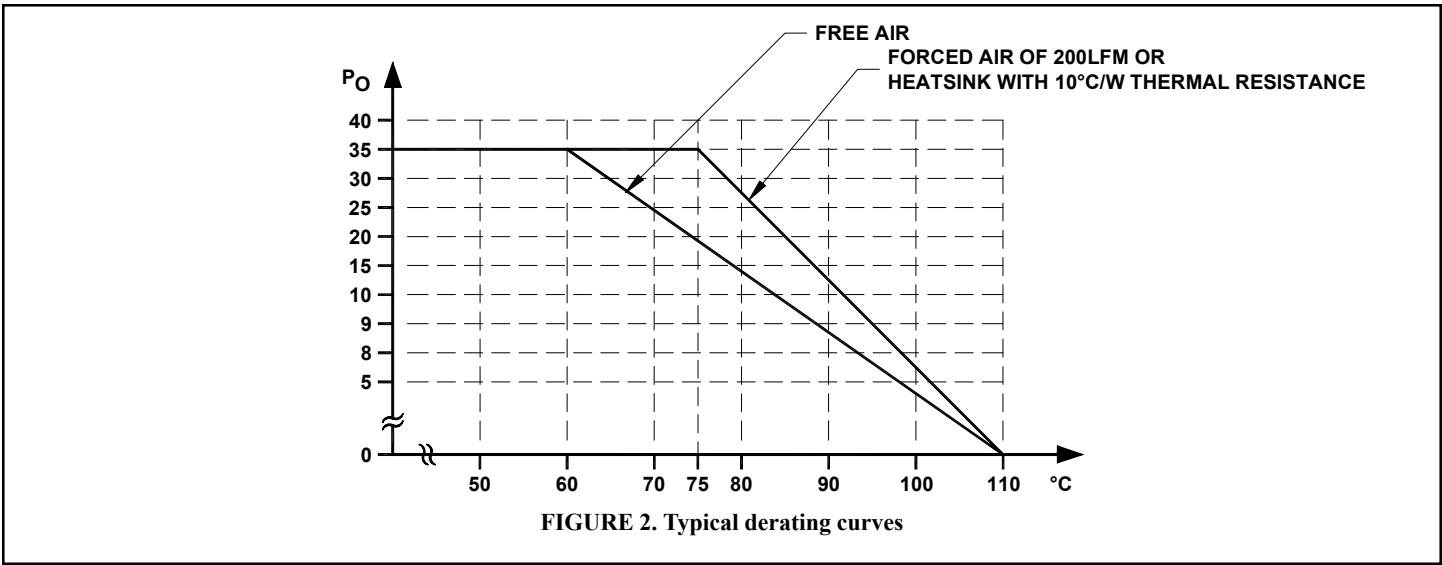

**EXTERNAL TRIMMING OF OUTPUT VOLTAGES (DUAL)**

To trim the output voltage DOWN, connect a 5% ¼W 1.5MΩ resistor (DO NOT GO BELOW 1MΩ) between the +V<sub>O1</sub> (Pin 7) output and trim pin of the converter. To trim the output voltage UP, connect a 5% ¼W resistor between the -V<sub>O1</sub> (Pin 8) output and trim pins of the converter. For UP/DOWN trimming capability, connect a 2MΩ potentiometer between the + and - output pins, with the wiper arm connected to the trim pin.

The trim resistors/potentiometer can be connected at the con-

verter output pins or the load. However, if connected at the load, the resistance of the runs becomes part of the feedback network which improves load regulation. If the load is some distance from the converter, the use of #20 gauge wire is recommended to avoid excessive voltage drop due to the resistance of the circuit paths. See our application notes:

- DC-001: Testing Transient Response in DC/DC Converters
- DC-004: Thermal Consideration for DC/DC Converters

**EXTERNAL SYNCHRONIZATION**

A TTL signal applied at the SYNC pin of the converter will synchronize the switching frequency of the converter to that of the TTL input signal. The external (TTL) frequency must be equal or higher than the converter’s frequency. At the positive-going edge of the applied pulse, the internal power-switching transistor turns off and the PWM discharges its timing capacitor. At the negative-going edge, the PWM resumes normal operation. The minimum positive pulse width of the TTL signal must be 300nS minimum

and its frequency between 85kHz and 120kHz. NOTE: Higher frequencies will reduce the efficiency of the converter and wide TTL pulses will force the PWM to follow the external TTL width modulation, which may effect regulation. A high TTL signal at the SYNC pin of the converter will turn the converter off. An internal pull-down resistor will keep this pin low when it is not used. A pulse differentiator (see Figure 4) can be used to shape a square wave sync signal as shown in Figure 3.

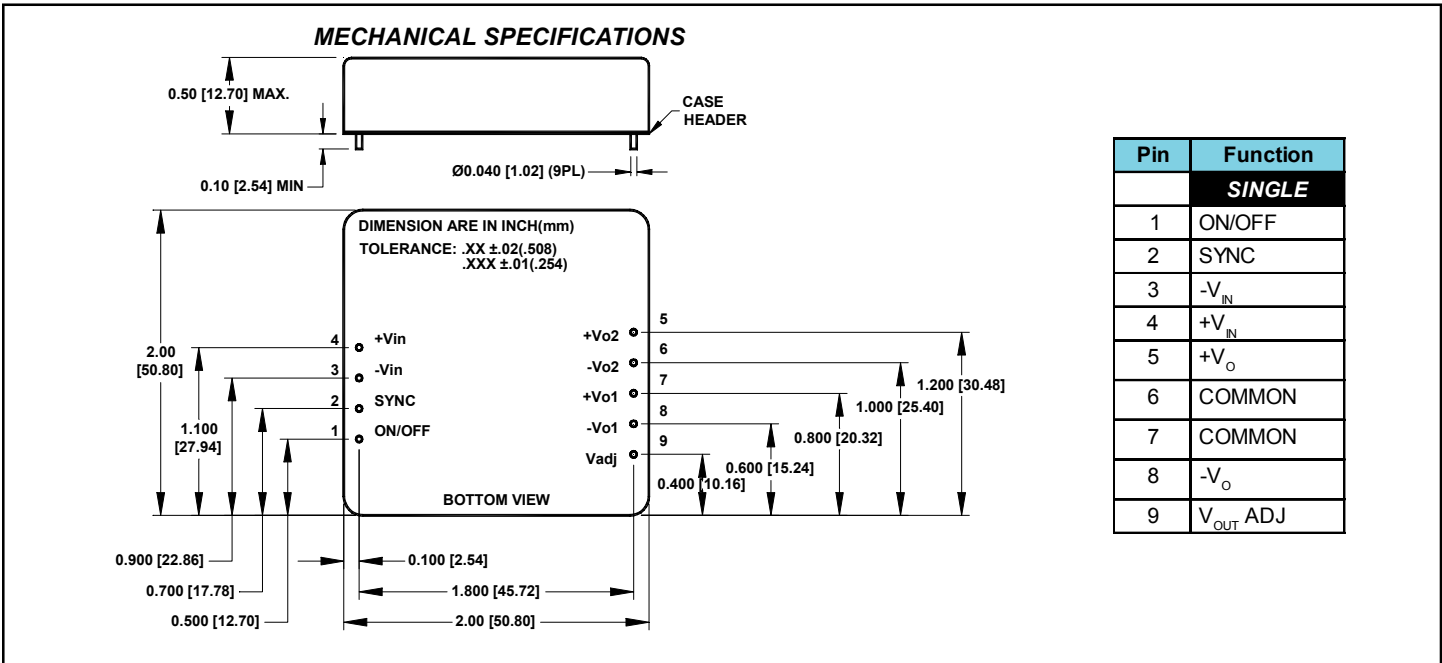

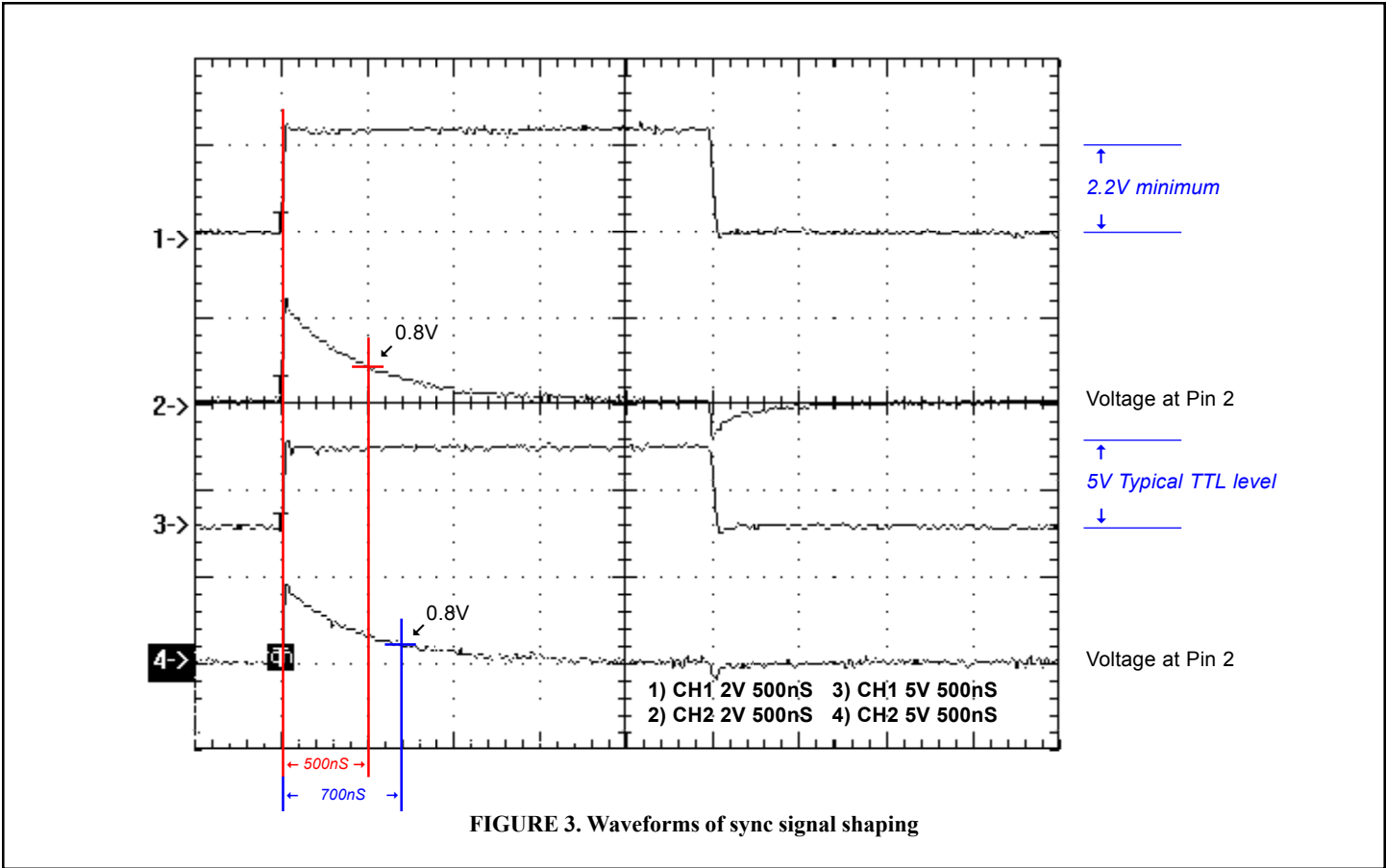

**SYNC SIGNAL SHAPING**

As described in External Synchronization, the PWM of the converter requires a TTL signal of 0.8Vdc to 2Vdc minimum amplitude and minimum duration of 300nS. When such a signal is not available (through one shot multivibrator or other pulse-shaping circuits) a C-R differentiator, such as the one in Figure 4, can be used to shape a square wave TTL signal. As is shown by the oscil-

logram in Figure 3, the positive edge of the sync pulse must be 2V minimum and the decaying exponential must reach the low 0.8Vdc in 300nS minimum from the positive edge. The parallel diode with the resistor is a small signal switching diode or a Schottky signal diode with 0.3 to 0.5V forward drop, it is used to clamp the voltage at pin 2@-0.5Vdc.

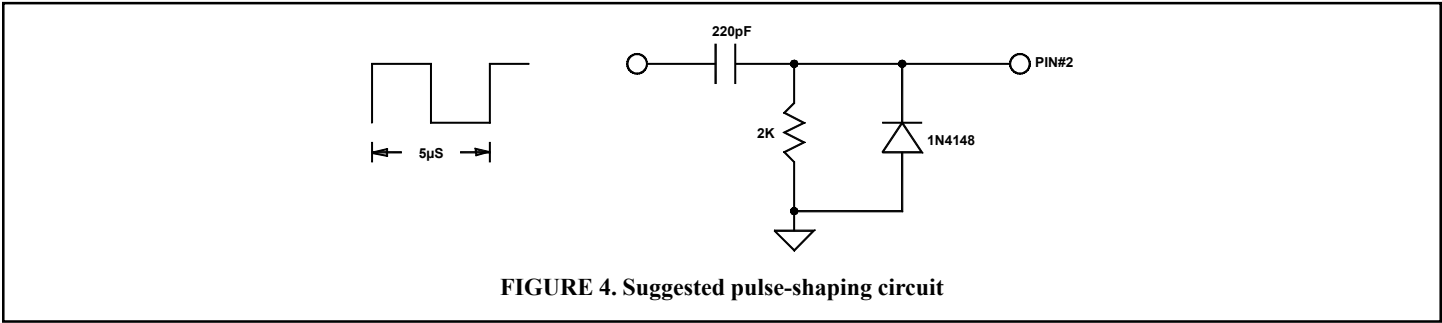

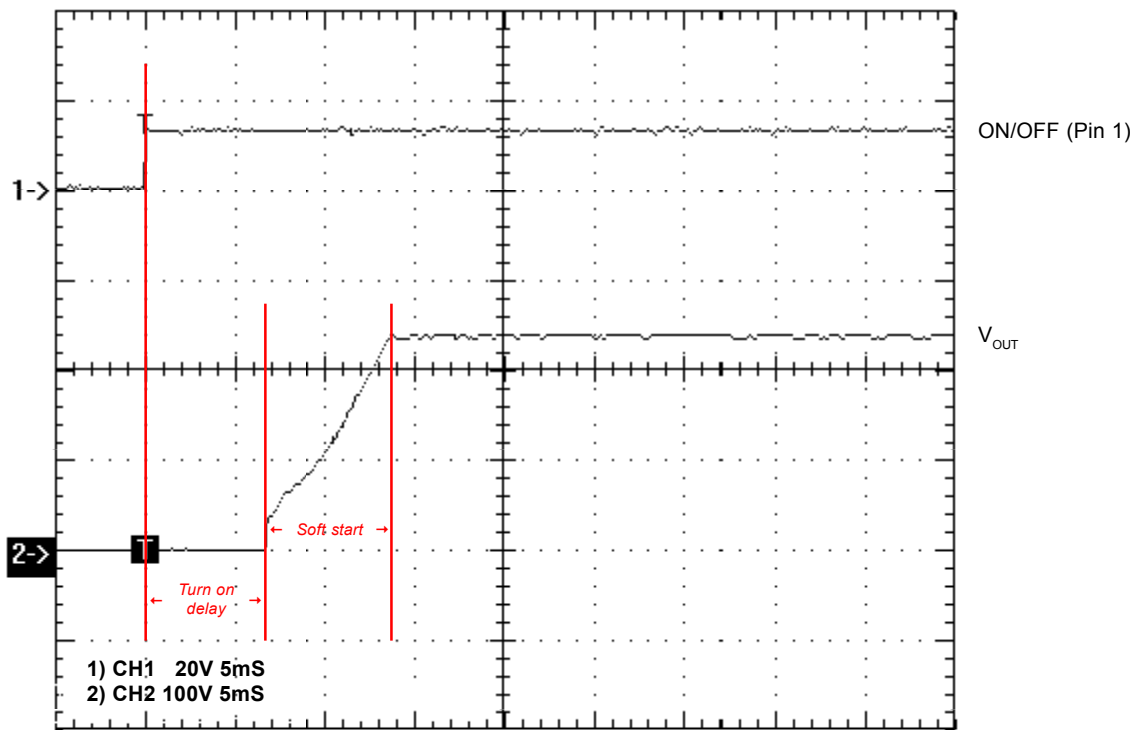

FIGURE 5. Turn on delay with soft start

### SHORT CIRCUIT PROTECTION

The converter has a dual short circuit protection feature. At the input side of the converter, two short circuit current comparators are used to monitor the input current of the converter. They are biased at different voltage levels; the lower threshold (LTH) comparator provides the power limiting function of the converter. Under normal operating conditions, the LTH comparator limits the output power of the converter when the maximum output power is exceeded.

When a hard short is applied across the output of the converter and the input current exceeds the set threshold of the second comparator, the converter goes into shutdown mode, the overcurrent latch is set and the converter is turned off. The converter will turn on again when its input voltage is recycled (OFF-ON) or if the ON/OFF pin is used to turn the converter on and off. The time required for the ON/OFF pin to be held low is between 100mS and 800mS.