



10W HIGH-VOLTAGE DC/DC CONVERTER

5Vdc to 240Vdc Output Range

Key Features

- Efficiency up to 84%
- Wide input voltage range (2:1)
(4:1 available upon request)
- Input-to-output isolation
- Soft start
- Hot pluggable
- Short circuit protection
- Thermal protection
- Adjustable outputs
- 50 μ A off state current



Beta Dyne is protected under various patents, including but not limited to U.S. Patent numbers: 5,777,519; 6,188,276; 6,262,901; 6,452,818; 6,473,3171.

Applications

- Telecom
- DSL Systems
- Remote Feed Systems
- Battery Power Systems

Functional Description

The 10W High-Voltage DC/DC Converter family is designed for telecommunication applications including xDSL remote power feed. The converters accept wide input voltage ranges with nominal inputs of 24, 48 and 120V_{IN}. Outputs can be single or dual and be set as two independent adjustable, isolated outputs from 5V_{OUT} to 120V_{OUT}. Additional features include total input-to-output isolation, short circuit protection, thermal protection, soft start, adjustable outputs, hot pluggability and efficiency up to 84%.

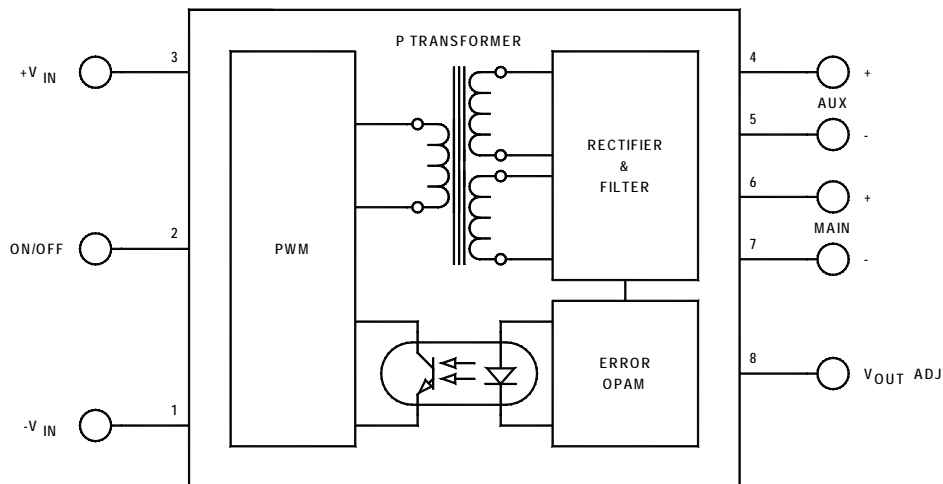

Typical Block Diagram

Electrical Specifications

ABSOLUTE MAXIMUM RATINGS

Unless otherwise specified, all parameters are given under typical +25°C with nominal input voltage and under full output load conditions.

PARAMETER	CONDITION / NOTE	MIN	TYP	MAX	UNIT
Input Voltage Range	175% of Nominal Input Line				
Output Short Circuit Duration	Continuous				
Internal Power Dissipation				3.4	W

INPUT SPECIFICATIONS

PARAMETER	CONDITION / NOTE	MIN	TYP	MAX	UNIT
Input Voltage Range(2:1)	See Model Selection Guide (contact factory for other input ranges)				
Input Filter*	RC				
Reflected Ripple current	See Model Selection guide				
Reverse Voltage Protection	Pararell Diode		5		a
On/Off	Reference to -VIN				
Voltage	Open		10		Vdc
Unit On	Open				
Unit Off	Short to -VIN				
Off State Current	Pin 2 short to Pin 3		50	120	µA
Turn On Delay	Including soft start	7	10	15	mS
Startup Input Voltage		11	16		Vdc

* The RC input filter utilizes the R_{ON} of the series MOSFET transistor which is part of the hot pluggable circuit. The benefits of this RC filters are the reduction of inrush current by approximately 27dB and reflected ripple attenuation by 8dB. The penalty for the hot pluggability and the RC filter is 1% to 2% reduction of the converter's efficiency. See Figures 4 and 5.

OUTPUT SPECIFICATIONS

PARAMETER	CONDITION / NOTE	MIN	TYP	MAX	UNIT
Voltage and Current Ratings	See Model Selection Guide				
Output Voltage Accuracy			±1		%
Voltage Balance, (Dual Outputs)	Equally loaded outputs		±1		%
Ripple & Noise (20MHZ BW)			±1		%
Line Regulation			±1		%
Load Regulation			±1		%
Temperature Coefficient @ FL			0.02		%/°C
Short Circuit Protection	Continuous ,Current Limit				
Short Circuit Restart	Automatic				
Transient Response Time (to within 1% of V _{OUT})	50% FL to FL to 100% FL to 50% FL		50		µs
For Dual Isolated Output Balance, Load or Line Regulation	With balanced loads			5	%
Output Adjust Range	See Figure 1,2 and 3		±5	±10	%

GENERAL SPECIFICATIONS

PARAMETER	CONDITION / NOTE	MIN	TYP	MAX	UNIT
Efficiency	See Model Selection Guide				
Isolation Voltage (1 min.)			1500		Vdc
Isolation Resistance			10 ⁹		T
Isolation Capacitance			300		pF
Switching Frequency		108	125	130	kHz

ENVIRONMENTAL SPECIFICATIONS

PARAMETER	CONDITION / NOTE	MIN	TYP	MAX	UNIT
Operating Temperature, Industrial (Ambient)*	(Contact factory for -55°C to +85°C)	-40		+75	°C
Storage Temperature Range		-60		+105	°C
Derating	None required				
Thermal shutdown	Case temperature (input power must be recycled)	96	100	104	°C
Thermal Hysteresis			30		°C
Humidity	Up to 95% non-condensing				
Cooling	Free-air convection				
EMI/RFI	per MIL-HNBK-217F (Ground benign,+25°C)		1.2x10 ⁶		hours

PHYSICAL CHARACTERISTICS

PARAMETER	CONDITION / NOTE	MIN	TYP	MAX	UNIT
Dimensions (L×W×H)	2.00×1.00×0.395 in. (50.80×25.40×10.03mm)				
Weight	1.04 oz. (30g)				
Case Material	Coated metal				
Shielding	Six -sided continuous				
Case Connection, 24V _{IN}	-Input				
Case Connection, 48 , 120V _{IN}	+Input				

Model Selection Guide

MODEL NUMBER	INPUT				Reflected Ripple (mA _{PP})	OUTPUT		
	Voltage (Vdc)		Current (mA)			Voltage (Vdc)	Current (mA)	Efficiency Full Load (%)
	Nominal	Range	No Load	Full Load				
5S2.5/24	24	18-36	10	280	80	2.5	2000	74
5S3.3/24	24	18-36	10	280	80	3.3	1500	74
5S5/24	24	18-36	10	275	80	5	1000	74
5S12/24	24	18-36	10	280	80	12	420	74
5S15/24	24	18-36	10	280	80	15	330	74
5S120/24	24	18-36	10	270	80	120	42	78
10S2.5/48	48	36-72	5	278	90	2.5	4000	78
10S3.3/48	48	36-72	5	278	90	3.3	3030	78
10S5/48	48	36-72	5	260	90	5	2000	80
10S12/48	48	36-72	5	278	90	12	840	78
10S15/48	48	36-72	5	270	90	15	660	78
10S120/48	48	36-72	5	245	90	120	84	84
10S2.5/120	120	75-140	5	108	100	2.5	4000	77
10S3.3/120	120	75-140	5	108	100	3.3	3030	77
10S5/120	120	75-140	5	108	100	5	2000	77
10S12/120	120	75-141	5	106	100	12	840	78
10S15/120	120	75-142	5	106	100	15	660	78
5D5/24*	24	18-36	10	275	80	±5	±500	74
5D12/24*	24	18-36	10	280	80	±12	±210	72
5D15/24*	24	18-36	10	280	80	±15	±165	74
5D120/24*	24	18-36	10	280	80	±120	±21	75
10D5/48*	48	36-72	5	260	80	±5	±1000	80
10D12/48*	48	36-72	5	278	90	±12	±420	75
10D15/48*	48	36-72	5	255	90	±15	±330	81
10D120/48*	48	36-72	10	245	90	±120	±42	84
10D5/120*	120	75-140	5	108	100	±5	±1000	77
10D12/120*	120	75-140	5	108	100	±12	±420	78
10D15/120*	120	75-140	5	106	100	±15	±330	78

* For dual isolated outputs, insert an **I** after the last digit (see Ordering Guide).

** The maximum input current at any given input range measured at minimum input voltage is given as $1.6 \cdot I_{NOMINAL}$. Nominal input current is the typical value measured at the input of the converter under full-load room temperature and nominal input voltage (24, 48 and 120Vdc).

ORDERING GUIDE

_____ / _____ - **I**

Output Power (5 = 5W, 10 = 10W) _____

Number of Outputs (S = Single, D = Dual) _____

Output Voltage _____

Insert an **I** for dual isolated outputs, otherwise leave blank

Input Voltage _____

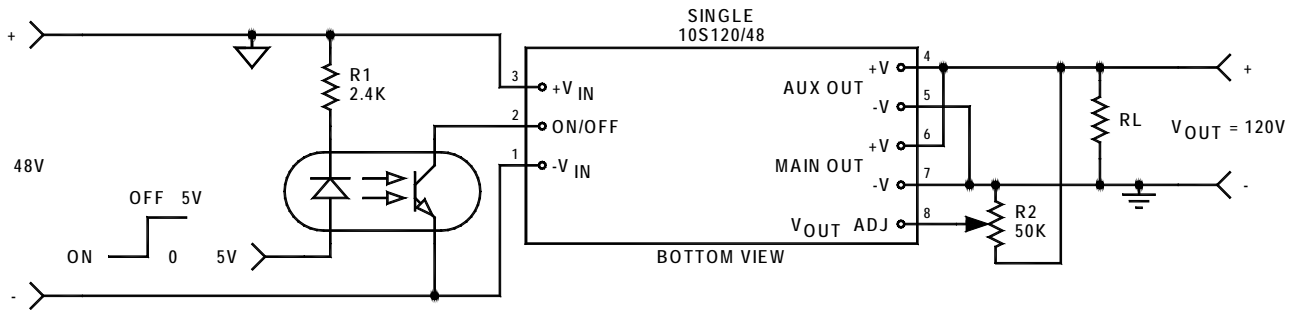

FIGURE 1. Single connection diagram

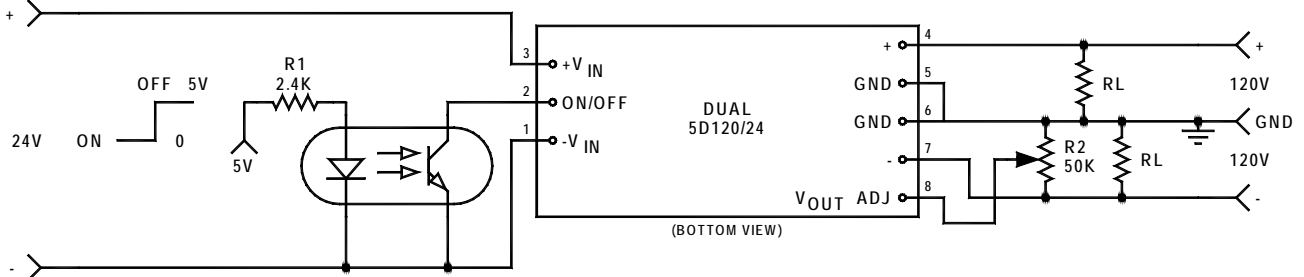

FIGURE 2. Dual connection diagram

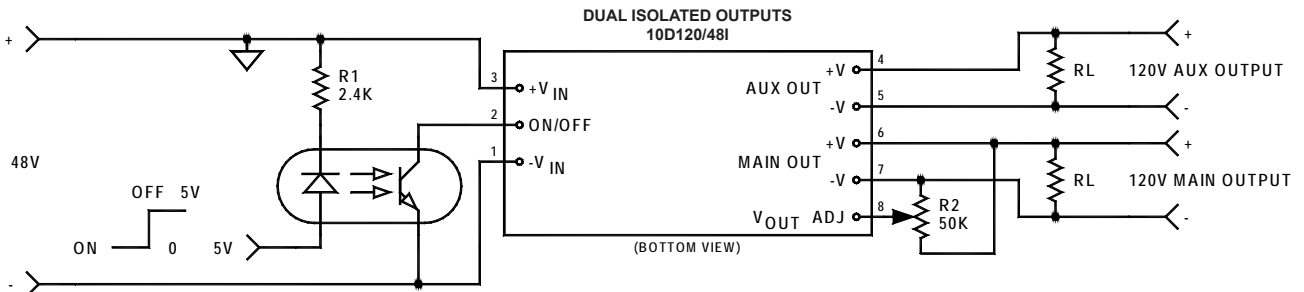
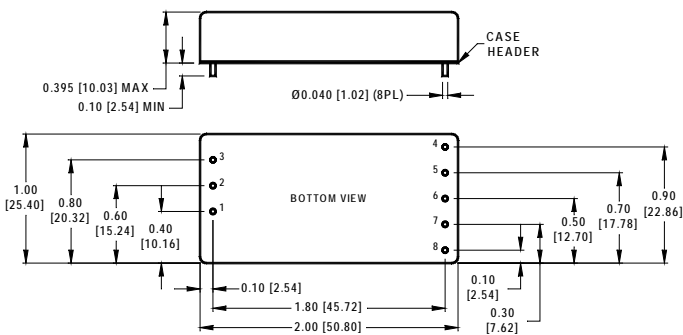

FIGURE 3. Dual isolated output connection diagram

MECHANICAL SPECIFICATIONS

in inches [mm]



Pin	Function		
	SINGLE (SEE FIG. 1)	DUAL (SEE FIG. 2)	DUAL ISOLATED (SEE FIG. 3)
1	-V _{IN}	-V _{IN}	-V _{IN}
2	ON/OFF	ON/OFF	ON/OFF
3	+V _{IN}	+V _{IN}	+V _{IN}
4	+V _{OUT} (CONNECT PIN 4 TO 6)	+V _{OUT}	+V _{OUT} AUX
5	-V _{OUT} (CONNECT PIN 5 TO PIN 7)	+V _{OUT}	GND AUX
6	+V _{OUT} (CONNECT PIN 4 TO PIN 6)	No Pin	+V _{OUT} MAIN
7	-V _{OUT} (CONNECT PIN 5 TO 7)	-V _{OUT}	GND MAIN
8	V _{OUT} ADJ	V _{OUT} ADJ	V _{OUT} ADJ

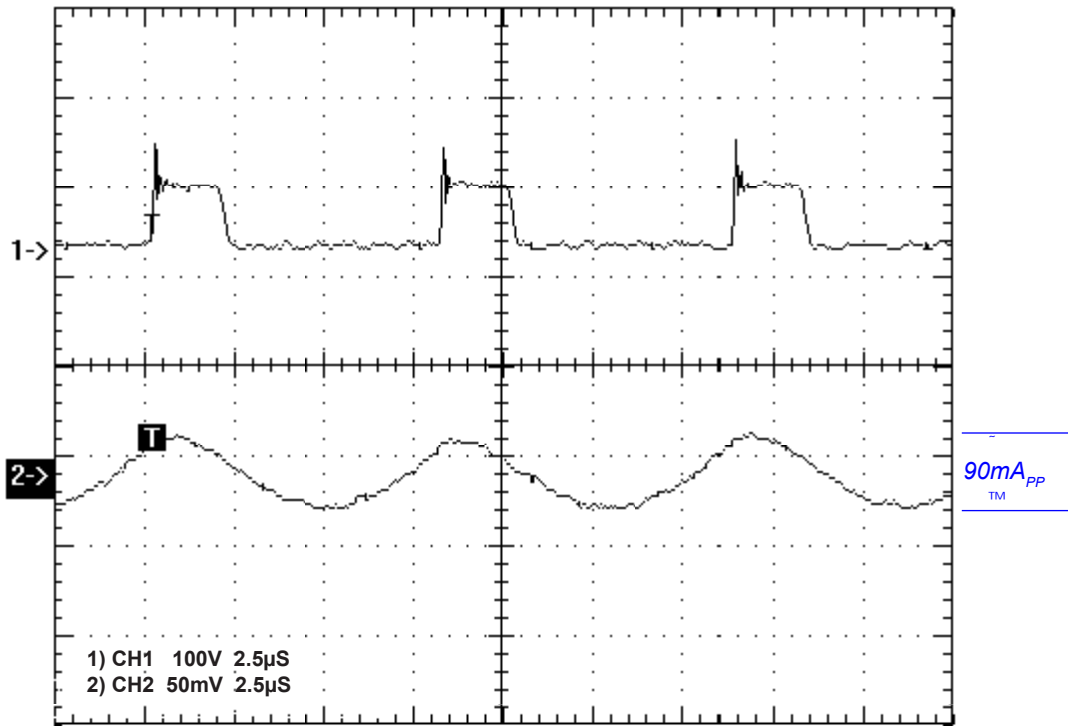

FIGURE 4A. (CH2) 10W reflected ripple *with* hot pluggable circuit, V_{IN} 36V

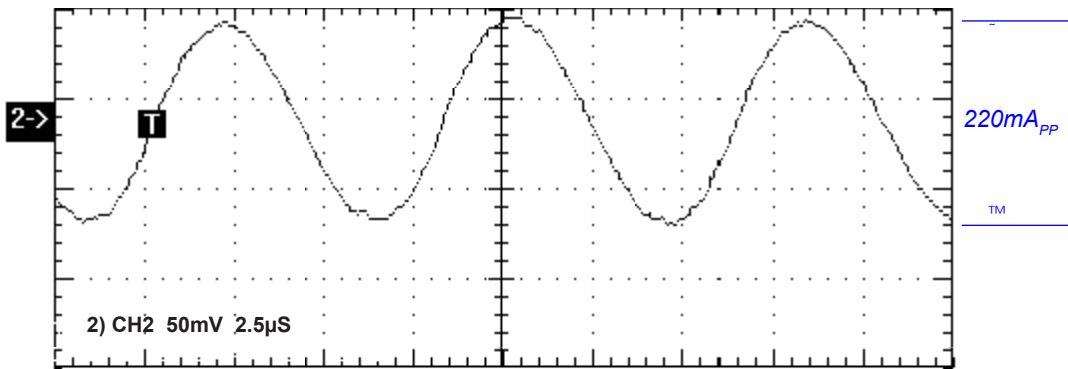

FIGURE 4B. (CH2) 10W reflected ripple *without* hot pluggable circuit

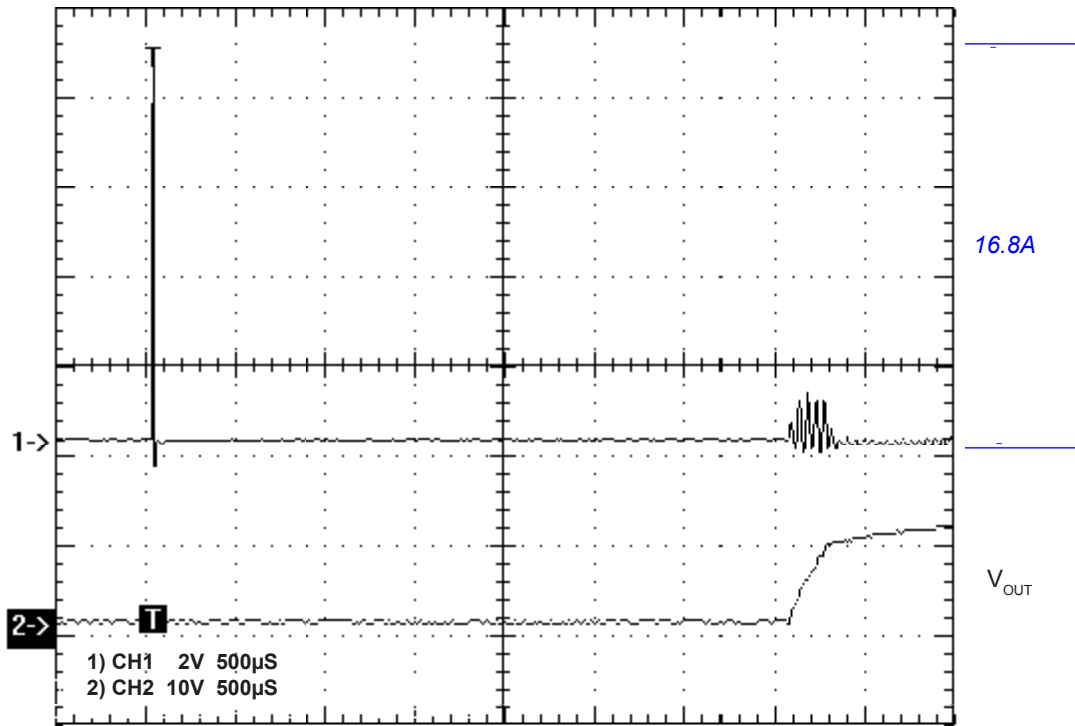

FIGURE 5A. (CH1) Inrush current *without* hot pluggable circuit ON
V_{IN} 48V, Current spike duration 5μS

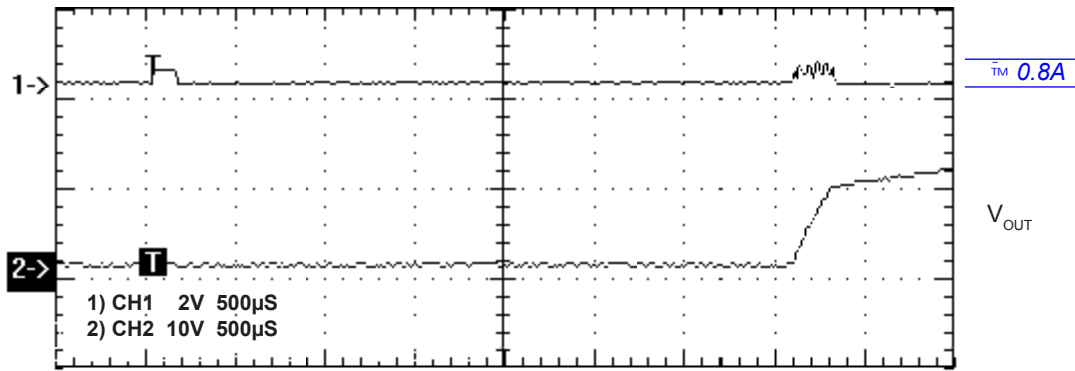

FIGURE 5B. (CH1) Inrush current *with* hot pluggable circuit ON